



NOTICE OF TELECONFERENCE MEETING & AGENDA
November 15, 2019 * 11:00 a.m. – 12:00 p.m.
Conference Call Line: 916-407-1517, no password necessary

TELECONFERENCE LOCATIONS

1055 Monterey Street, San Luis Obispo, CA 93408
168 W. Alisal St, 1st Floor, Salinas, CA 93901
501 Low Gap Rd #1060, Ukiah, CA 95482
168 N Edwards St., Independence, CA 93526
199 Edward St, Bishop CA 93514
600 A Street, Suite B, Davis, CA 95616
3156 Redwood Drive, Redway, CA 95560

- I. 11:00 am Opening Remarks & Roll Call**
Supervisor Fennell, CCA President
- II. 11:05 UPDATE on Internal CCA Operations, Membership & Outreach**
Cara Martinson, Executive Director, CCA
- III. 11:25 UPDATE on State & Local MOU**
Cara Martinson, Executive Director, CCA
- IV. 11:40 Cannabis 101 Series: METRC**
Adam Crabtree, NCS Analytics, CEO

V. Public Comment

The Board welcomes and encourages public participation in its meetings. The public may take appropriate opportunities to comment on any issue before the Board. If public comment is not specifically requested, members of the public should feel free to request an opportunity to comment. Each speaker is limited to two minutes. If you are addressing the Board on a non-agenda item, the Board may briefly respond to statements made or questions posed as allowed by the Brown Act (Government Code Section 54954.2). However, the Board's general policy is to refer items to staff for attention, or have a matter placed on a future Board agenda for a more comprehensive action or report.

VI. 12:00 p.m. Closing Comments & Adjournment

Except where noticed for a time certain, all times are approximate and subject to change. The meeting may be canceled or changed without notice. For verification, please contact cmartinson@cca.ca.gov. Action may be taken on any item on the agenda. Items may be taken out of order, tabled or held over to a subsequent meeting, to accommodate speakers, or to maintain a quorum.

A person with a disability who requires a modification or accommodation in order to participate in a public meeting of the California Cannabis Authority may, five (5) days prior to the date scheduled for a regular meeting of the Board of Directors, contact the Headquarters Office at 1100 K Street, Suite 101, Sacramento, California 95814, cmartinson@cca.ca.gov to request a disability related modification or accommodation in order to attend the meeting, or to request auxiliary aids or services in order to enable such person to understand the proceedings at such meeting.

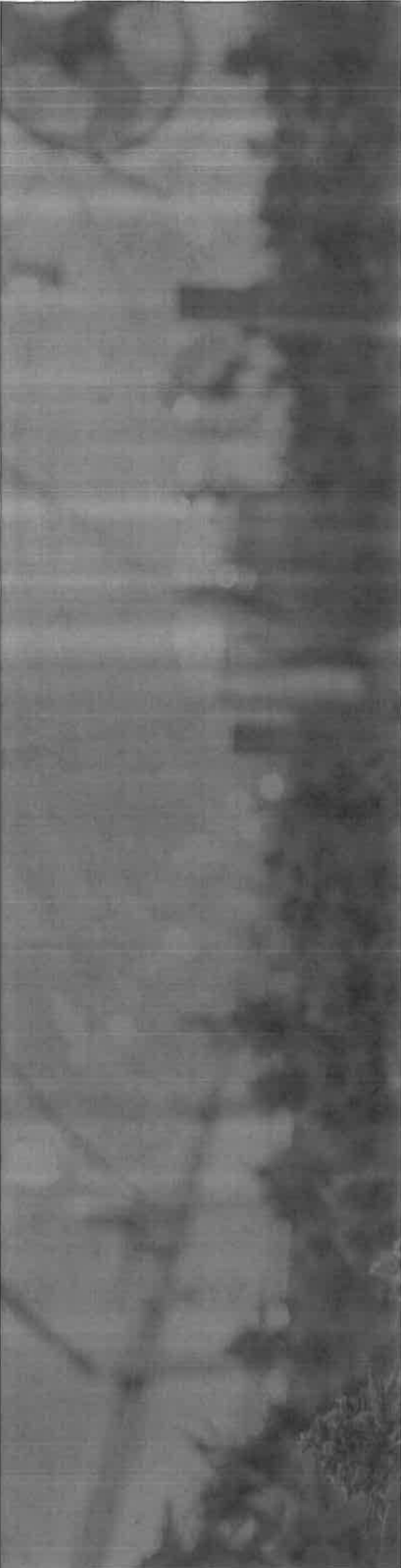

METRC 101

NCS ANALYTICS



WHAT IS METRC?

METRC is a track-and-trace system used to record commercial cannabis inventory, activity and movement across the cannabis supply chain, from seed to sale.



SEED TO SALE TRACKING

Seed to sale tracking is used to ensure licensed cannabis growers, manufacturers, distributors and retailers are in compliance with state tracking and reporting requirements.

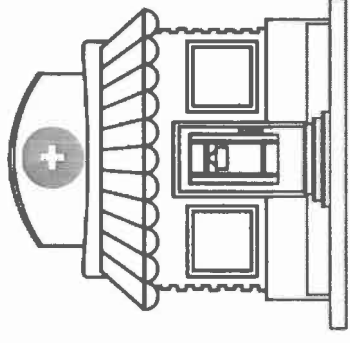
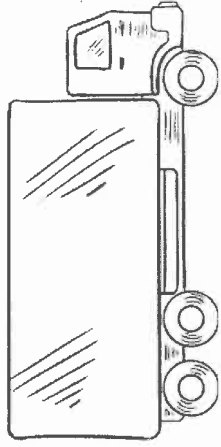
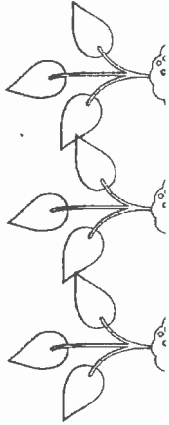

METRC: WHERE THEY WORK

- ALASKA
- CALIFORNIA
- DISTRICT OF COLUMBIA
- COLORADO
- LOUISIANA
- MASSACHUSETTS
- MARYLAND
- MICHIGAN
- MISSOURI
- MONTANA
- NEVADA
- OHIO
- OREGON

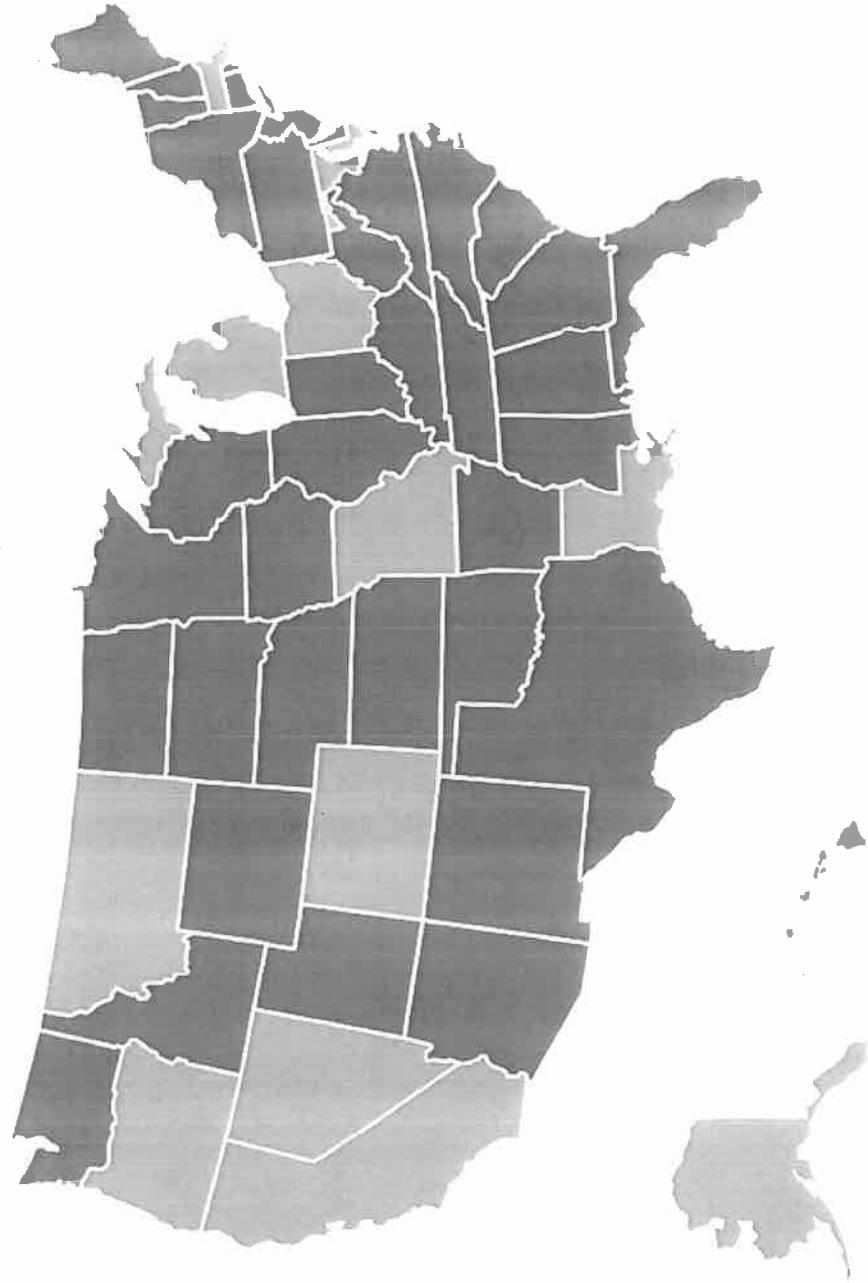

WHO USES METRC?

CANNABIS BUSINESSES

Licensed cannabis businesses receive a cloud-based reporting system to manage and report supply chain activities. To avoid manually entering data, most of these businesses utilize 3rd party point of sale systems to report their data.

REGULATORY AGENCIES

METRC was specifically designed for government agencies regulating the cannabis industry. It offers regulators the ability to oversee licensee activities to monitor and enforce compliance with state and local law.

TYPES OF DATA ENTERED INTO METRC

PLANTS: batch information, growth phase, strain, planted date...

HARVESTS: plant count, waste, packaged weight, wet weight, trim...

PACKAGES: contents, package label, ingredients, weight...

TRANSFERS: inventory, timing, origination, destination...

SALES: total quantity, unit of measure, total dollars...



HOW DATA IS IDENTIFIED IN METRC

RFID TAGS

There are two different types of tags, plant tags and package tags. Tags are used to track plants and packages through the cannabis life cycle. Regulators can scan tags to determine the origin of a plant or product. Tags are ordered through METRC directly.

- RFID = Radio Frequency Identification
- Tag IDs become available in METRC once the ordered tags are shipped
- Tags are assigned to....
 - immature plant lots (up to 100 immature plants)
 - individual plants once flowering
 - a package

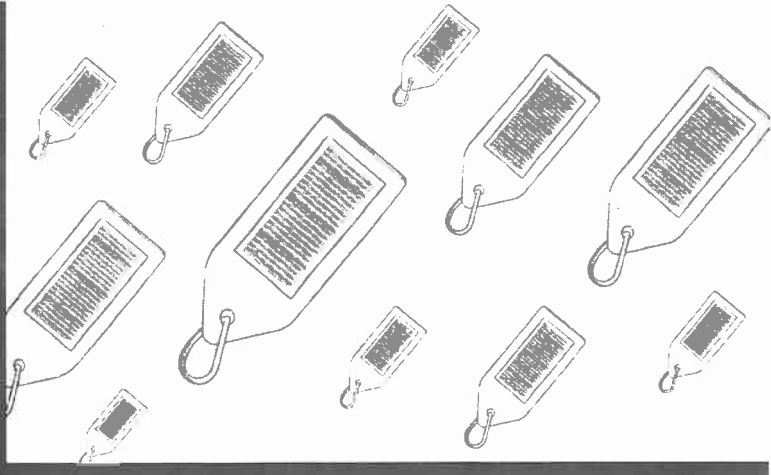

CANNABIS PLANT LIFE CYCLE

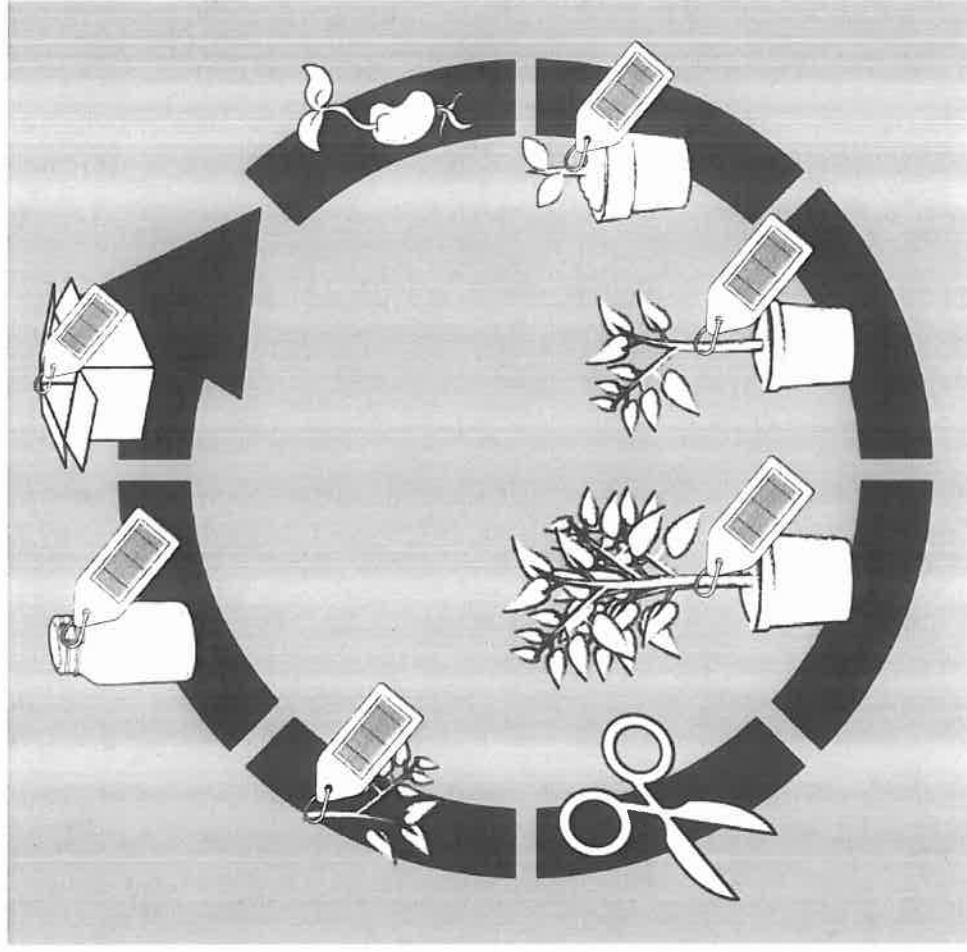
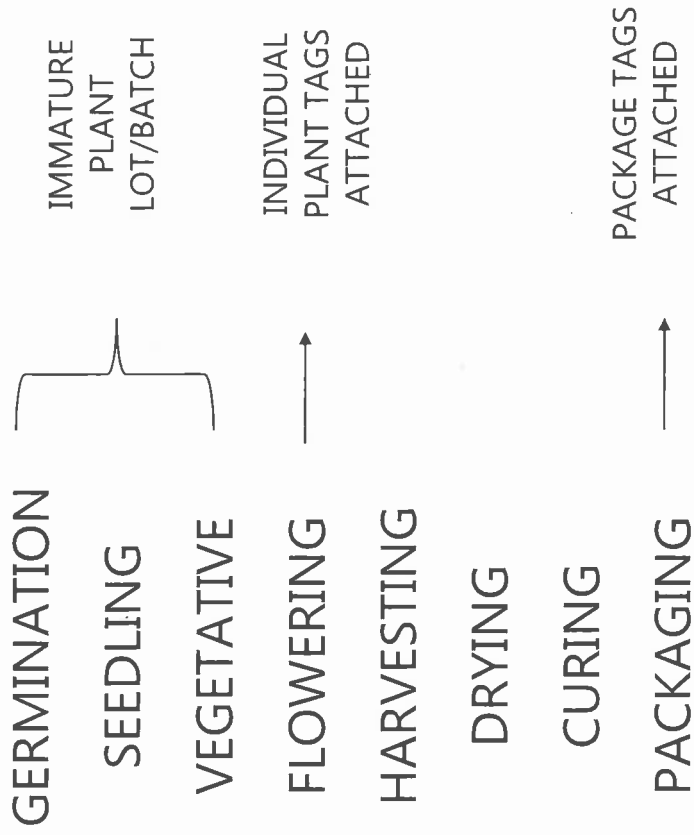

POINT OF SALE SYSTEMS + METRC

Point of Sale Systems (POS) integrate with METRC to provide licensees a more user friendly, efficient way to report their data.

Users of POS systems input information around plants, harvests, packages, sales and transfers directly into the app or website.

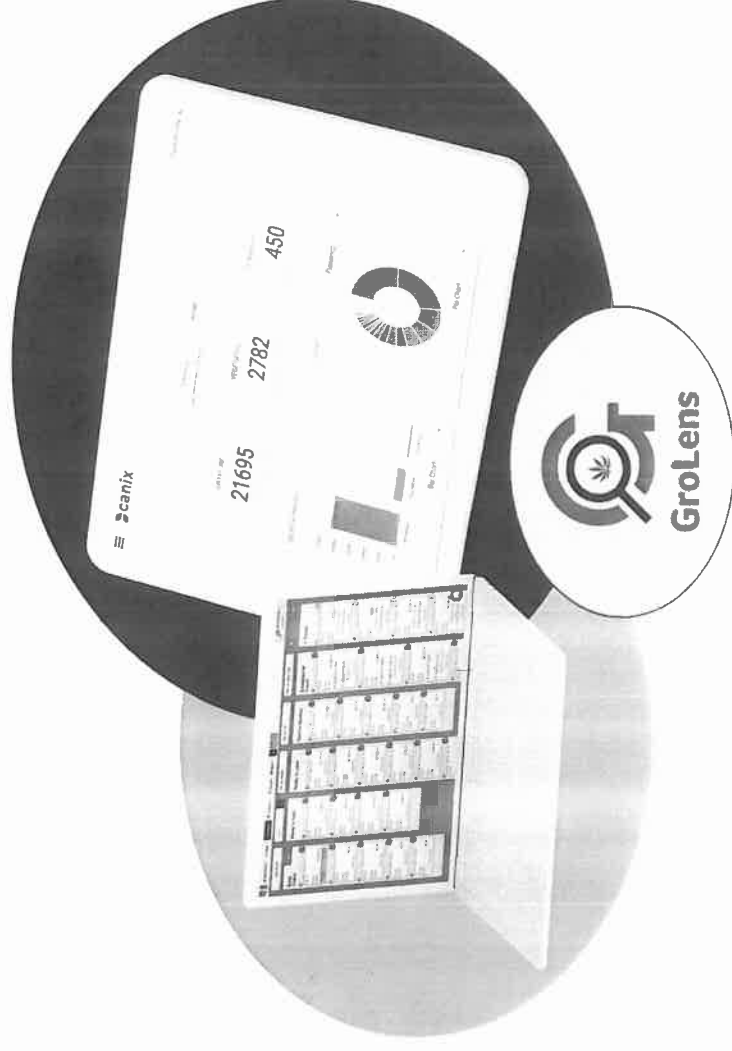

REPORTING

WHO: In California, all state-issued licensee holders are required to use the METRC system to record, track and maintain records about their cannabis inventory and activities.

WHEN: Activity is required to be entered into the METRC system within three days* of the event occurring.

*see CDFA § 8405 for more details

HOW: Data can be reported manually, directly to METRC via an internet connection and web browser. Information can also be submitted through a POS provider, via their application and an API connection.

WHY: Licensees must report all business activity in order to stay compliant, and in accordance with the regulations, as set out by the state.

WHERE TO FIND API DOCUMENTATION

More detailed information about METRC and their API can be found online.

<https://api-ca.metrc.com/Documentation/#getting-started>

API-INFO@METRC.COM

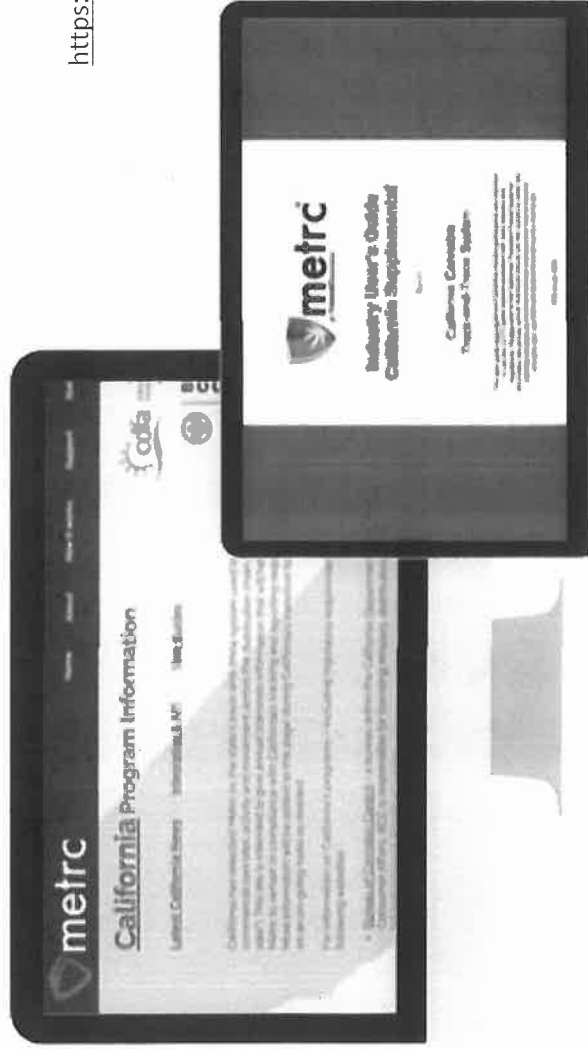

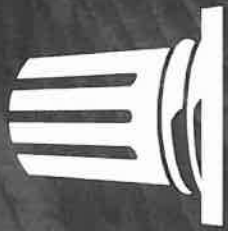

NCS

NCS
1800 Platte St
Denver, CO 80202
info@ncsanalytics.com
800.462.0787
NCSANALYTICS.COM